

PRIMED

SWITCH

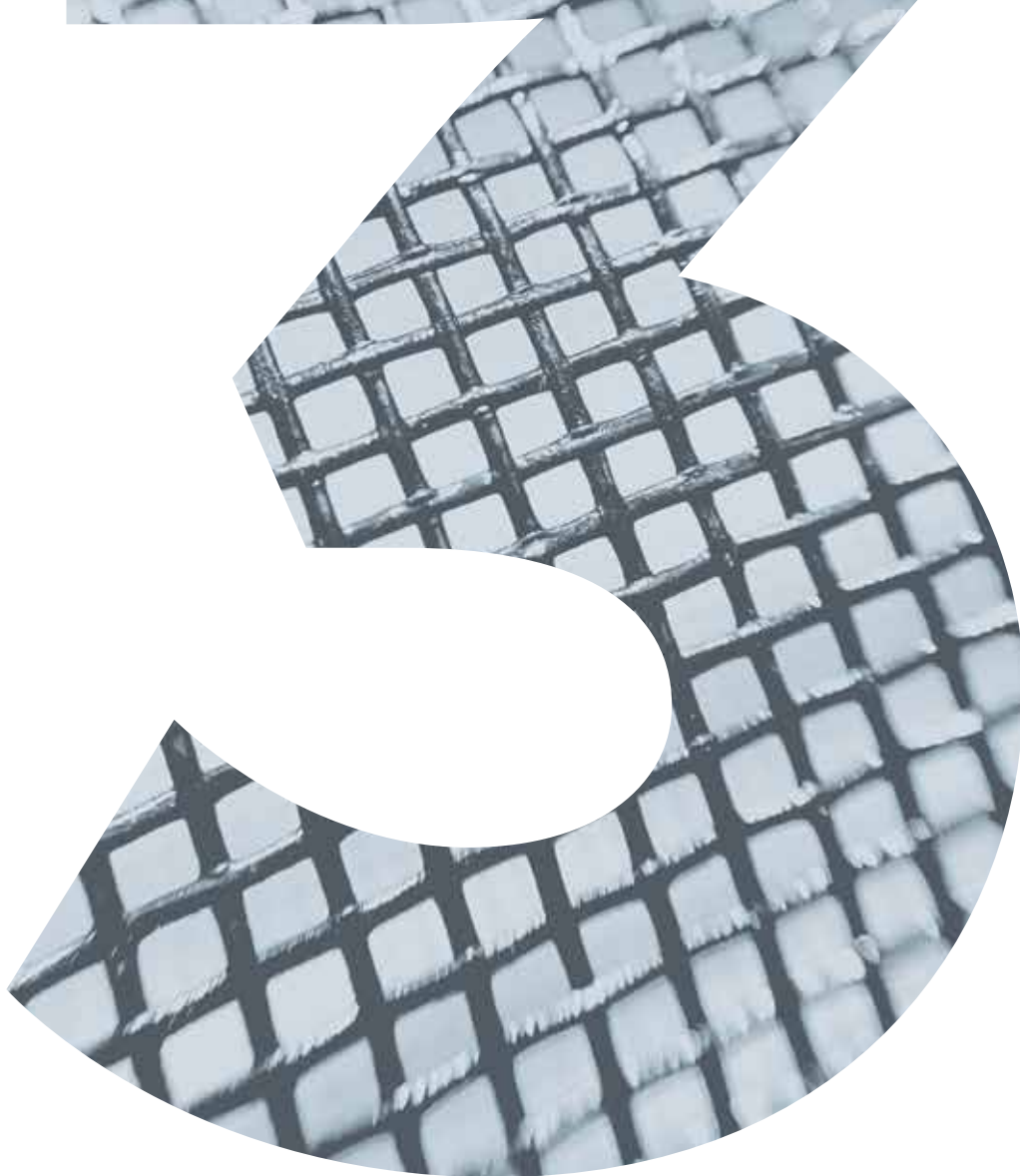

WWW.PRIMED.IT

PRIMED
LE ZANZIERE DEL FUTURO

COMMERCIALE@PRIMED.IT

SWITCH 3[®]

WWW.PRIMED.IT

SWITCH³

È PERFETTA, È SWITCH³.

SENZA
FILI

SENZA
FLESSO
METRI

+
AGGANCIO
SENZA VITI
(OPTIONAL)

+
SPAZIO DI
INSTALLAZIONE
45 MM

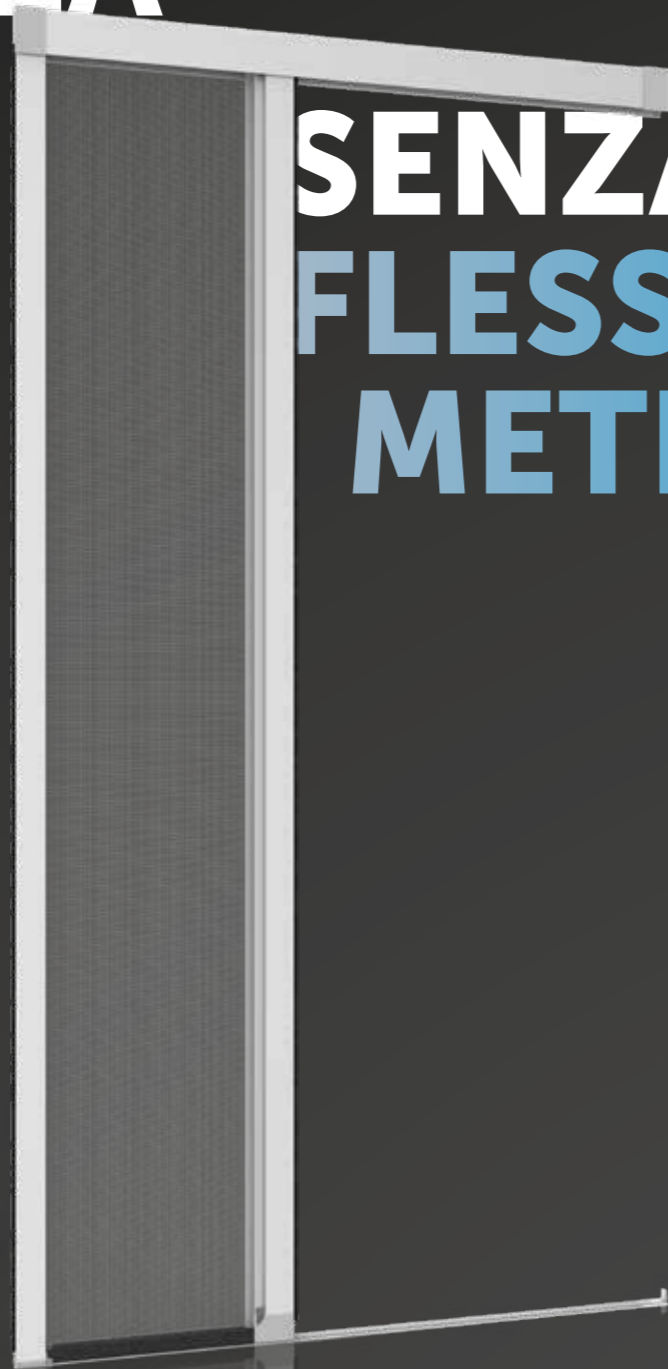

UN NUOVO STILE DI

MON
TAG
GIO

POSSIBILITÀ DI INSTALLAZIONE
IN ENTRAMBI I VERSI
DI APERTURA

SGANCIA,
RUOTA,
AGGANCIA.





IN DI CE

STANDARD

1 ANTA /06
2 ANTE /08

INCASSO50

1 ANTA /10
2 ANTE /12

INCASSO78

1 ANTA /14
2 ANTE /16

MAGIC

1 ANTA /18
2 ANTE

OPTIONAL ACCESSORI

OPTIONAL /20

TELI COLORI

TELI /22
COLORI /23

LISTINO PREZZI

LISTINO PREZZI /24

STANDARD

CHIUSURA MAGNETICA

SPAZIO INSTALLAZIONE **45MM**

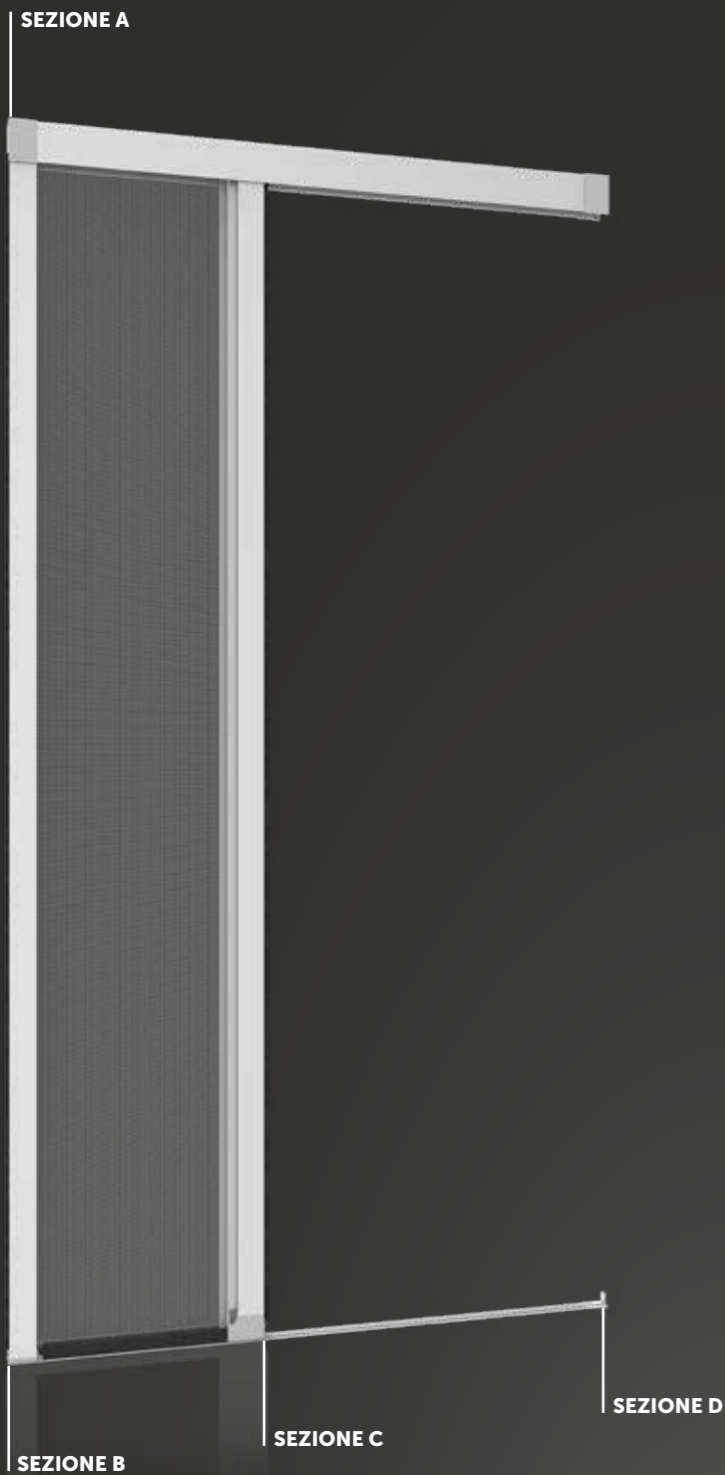

**INQUADRA IL QR CODE
CON IL TUO SMARTPHONE
E VISUALIZZA LE ISTRUZIONI
DI MONTAGGIO!**



**MONTAGGIO
STANDARD**



**MONTAGGIO
OPTIONAL**

OPTIONAL ACCESSORI

C	Compensatore singolo (lato cassonetto)
CM	Compensatore singolo magnetico (lato chiusura)
CCM	Compensatore doppio magnetico
ASV	Attacco senza viti
CSI	Chiusura sicura*
TOP	Attacco senza viti + chiusura sicura*

*La chiusura sicura e la variante TOP non sono compatibili con optional CM e CCM.

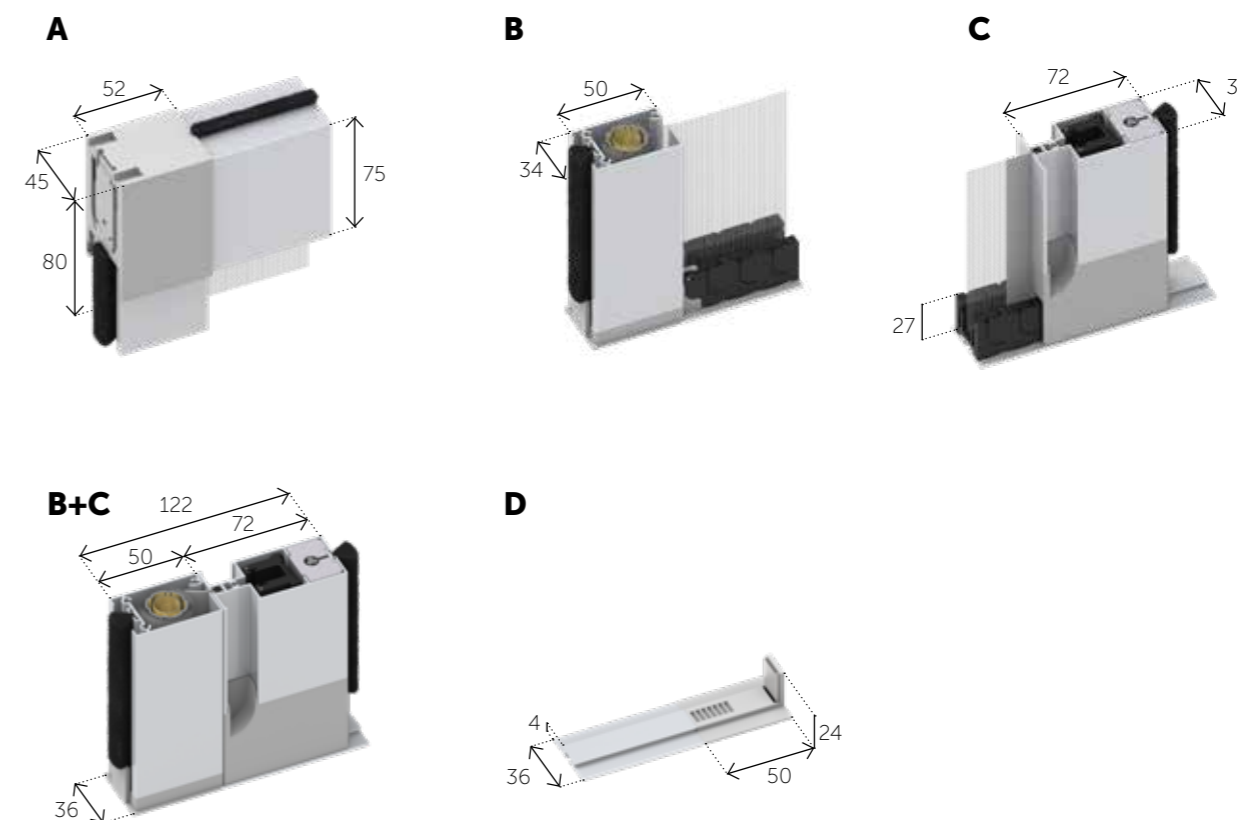

TELI

	COD.	DESCRIZIONE	DIMENSIONI MASSIME
	0	Fibra grigio	1600 x 2700
	RNE	Fibra nero	1600 x 2700
	BN	Fibra bianco/nero	1600 x 2700
	POL	Antipolline	1400 x 2700
	TUG	Pet screen light grigio	1000 x 2700
	TUN	Pet screen light nero	1000 x 2700

STANDARD

CHIUSURA MAGNETICA

SPAZIO INSTALLAZIONE **45MM**

SEZIONE A

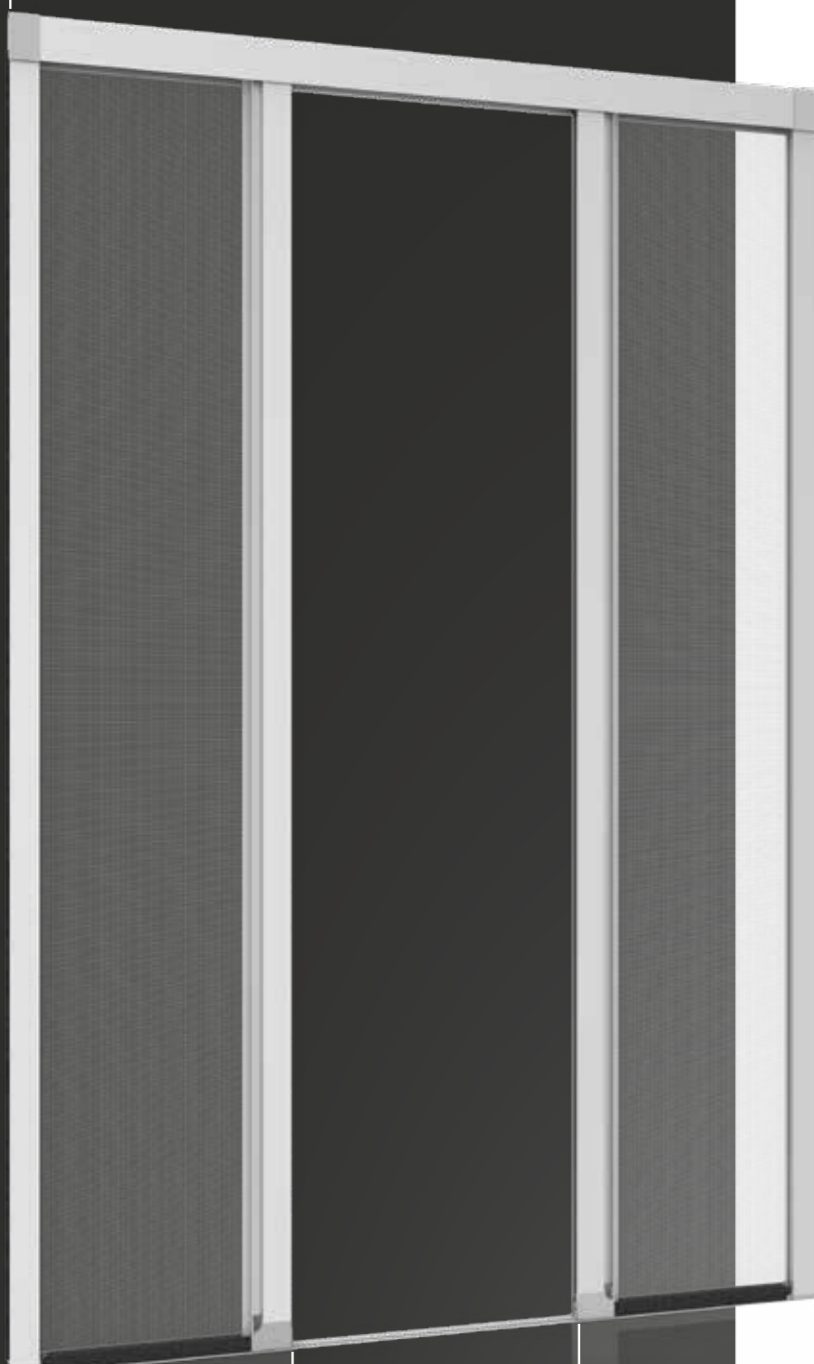

**INQUADRA IL QR CODE
CON IL TUO SMARTPHONE
E VISUALIZZA LE ISTRUZIONI
DI MONTAGGIO!**



**MONTAGGIO
STANDARD**



**MONTAGGIO
OPTIONAL**

OPTIONAL ACCESSORI

CDC	Con doppio compensatore
ASV	Attacco senza viti
TOP	Attacco senza viti + Chiusura sicura*
CSI	Chiusura sicura* (su un'anta)
2CS	Doppia chiusura sicura (su entrambe le ante)

*In caso di apertura asimmetrica occorre comunicare la posizione della chiusura sicura vista interna.

Per la variante TOP la chiusura sicura è prevista solo su una delle due ante.

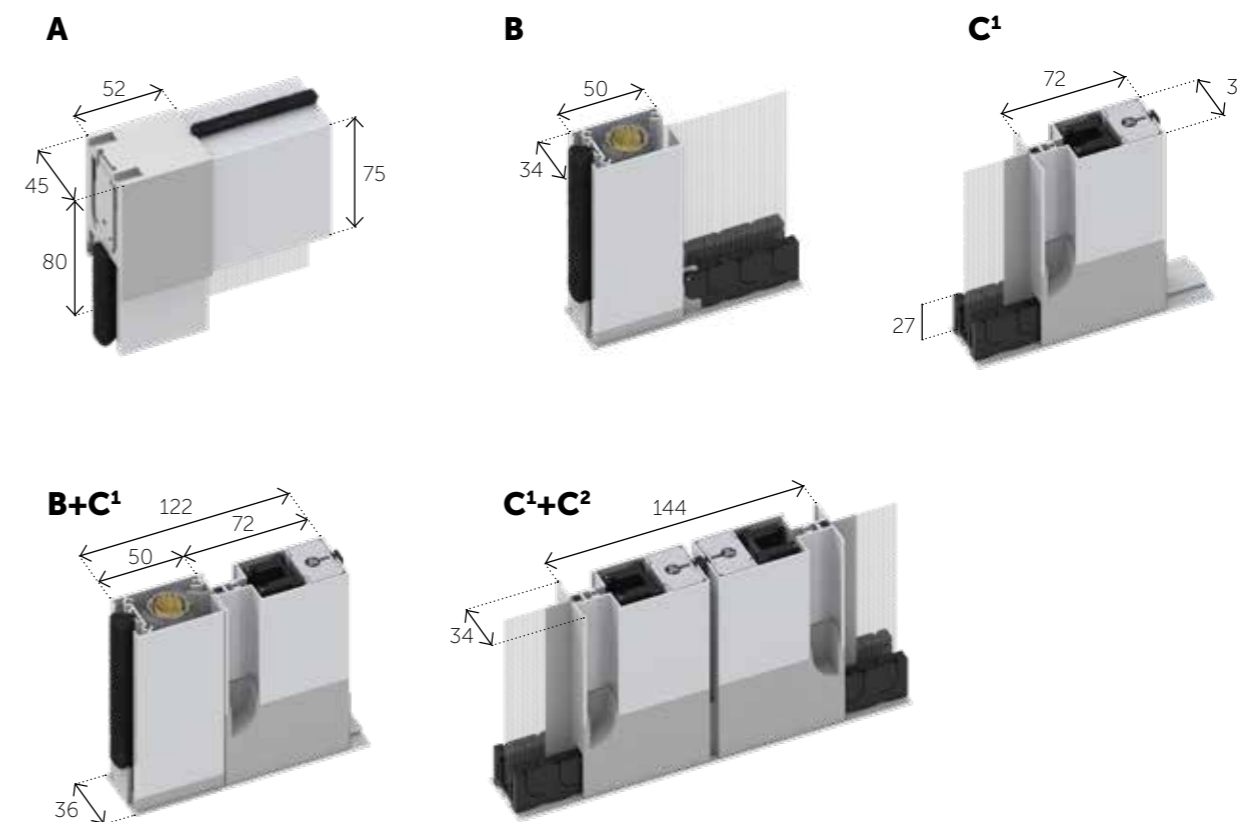

TELI

	COD.	DESCRIZIONE	DIMENSIONI MASSIME
	0	Fibra grigio	3200 x 2700
	RNE	Fibra nero	3200 x 2700
	BN	Fibra bianco/nero	3200 x 2700
	POL	Antipolline	2800 x 2700
	TUG	Pet screen light grigio	2000 x 2700
	TUN	Pet screen light nero	2000 x 2700

INCASSO50 | 1 ANTA

SENZA DISTANZIATORE SUPERIORE

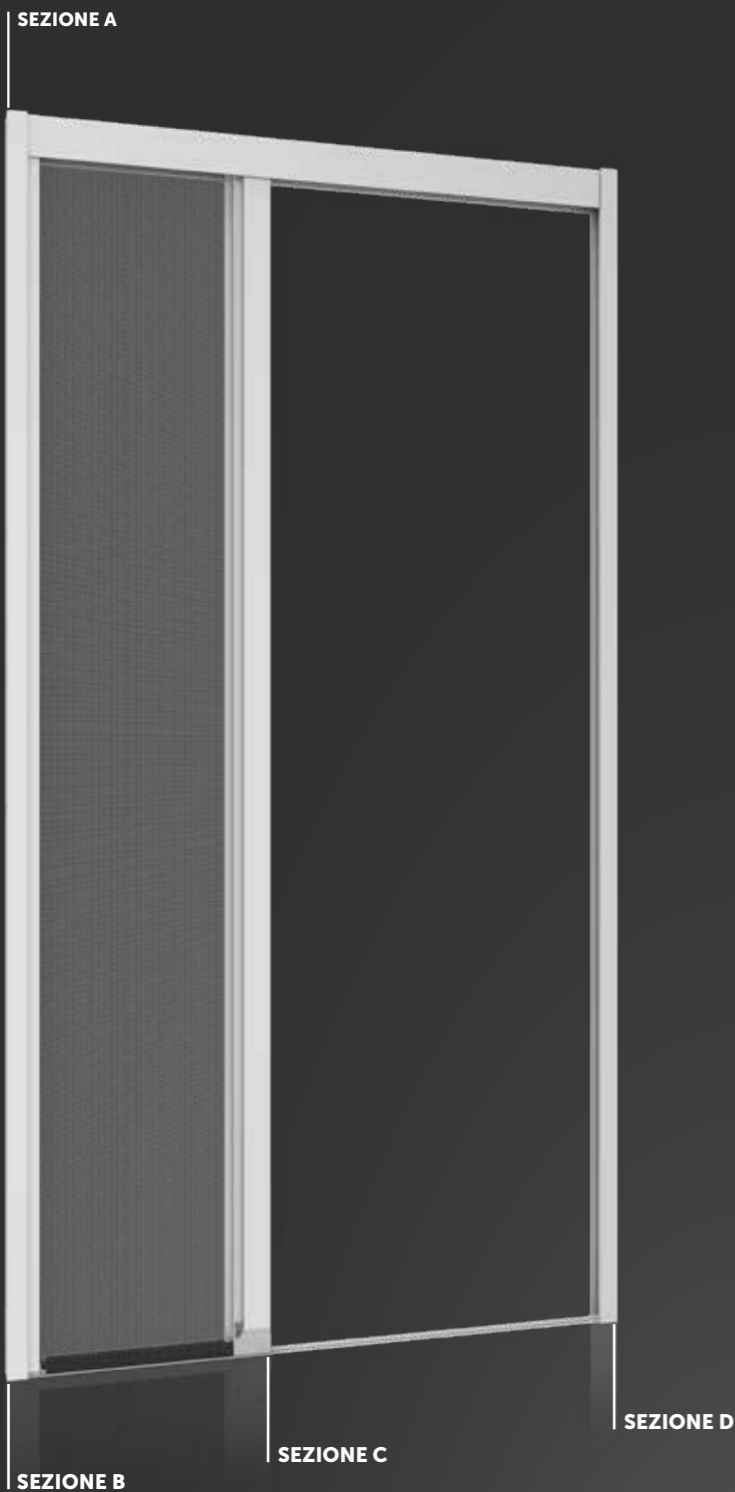

STANDARD
CHIUSURA MAGNETICA

SPAZIO INSTALLAZIONE **50MM**

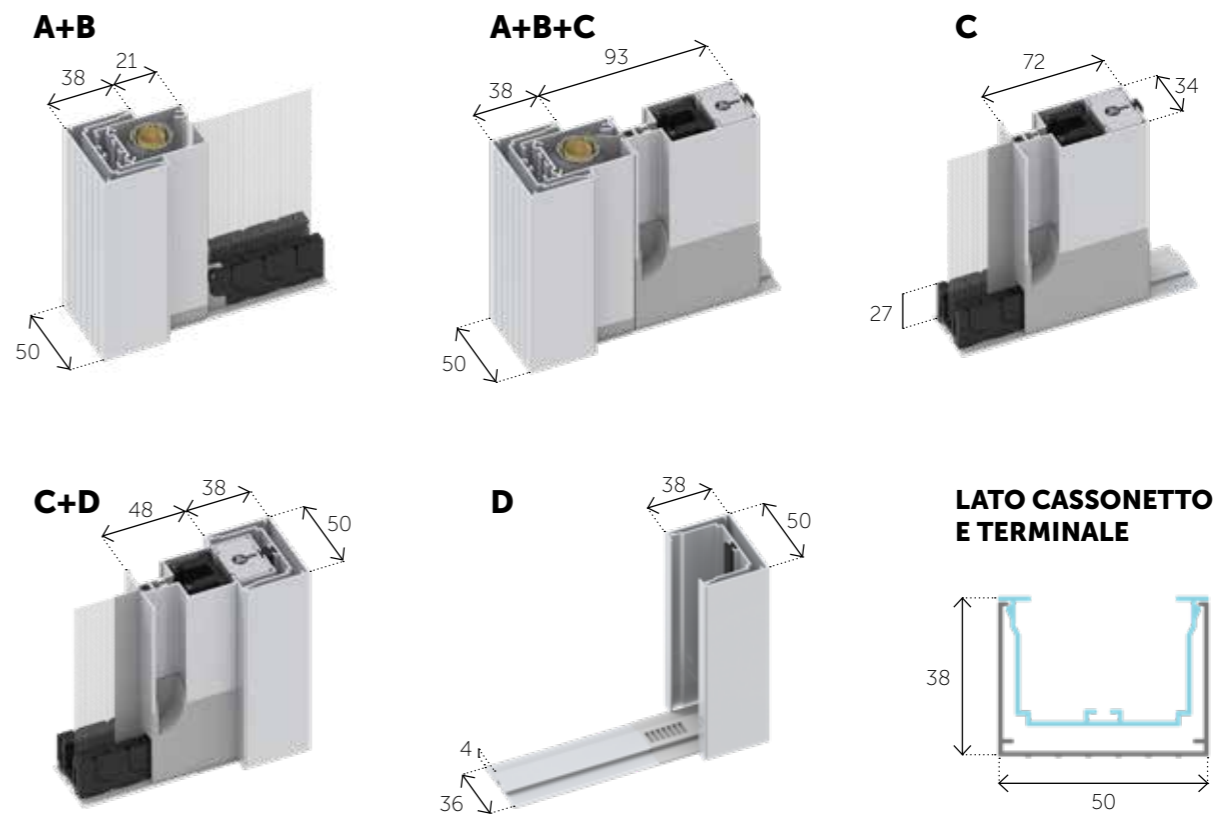

**INQUADRA IL QR CODE
 CON IL TUO SMARTPHONE
 E VISUALIZZA LE ISTRUZIONI
 DI MONTAGGIO!**



**MONTAGGIO
 INCASSO 1 ANTA**

TELI

	COD.	DESCRIZIONE	DIMENSIONI MASSIME
	0	Fibra grigio	1600 x 2700
	RNE	Fibra nero	1600 x 2700
	BN	Fibra bianco/nero	1600 x 2700
	POL	Antipolline	1400 x 2700
	TUG	Pet screen light grigio	1000 x 2700
	TUN	Pet screen light nero	1000 x 2700

INCASSO 50 | 2 ANTE

SENZA DISTANZIATORE SUPERIORE

STANDARD

 CHIUSURA MAGNETICA

SPAZIO INSTALLAZIONE **50MM**

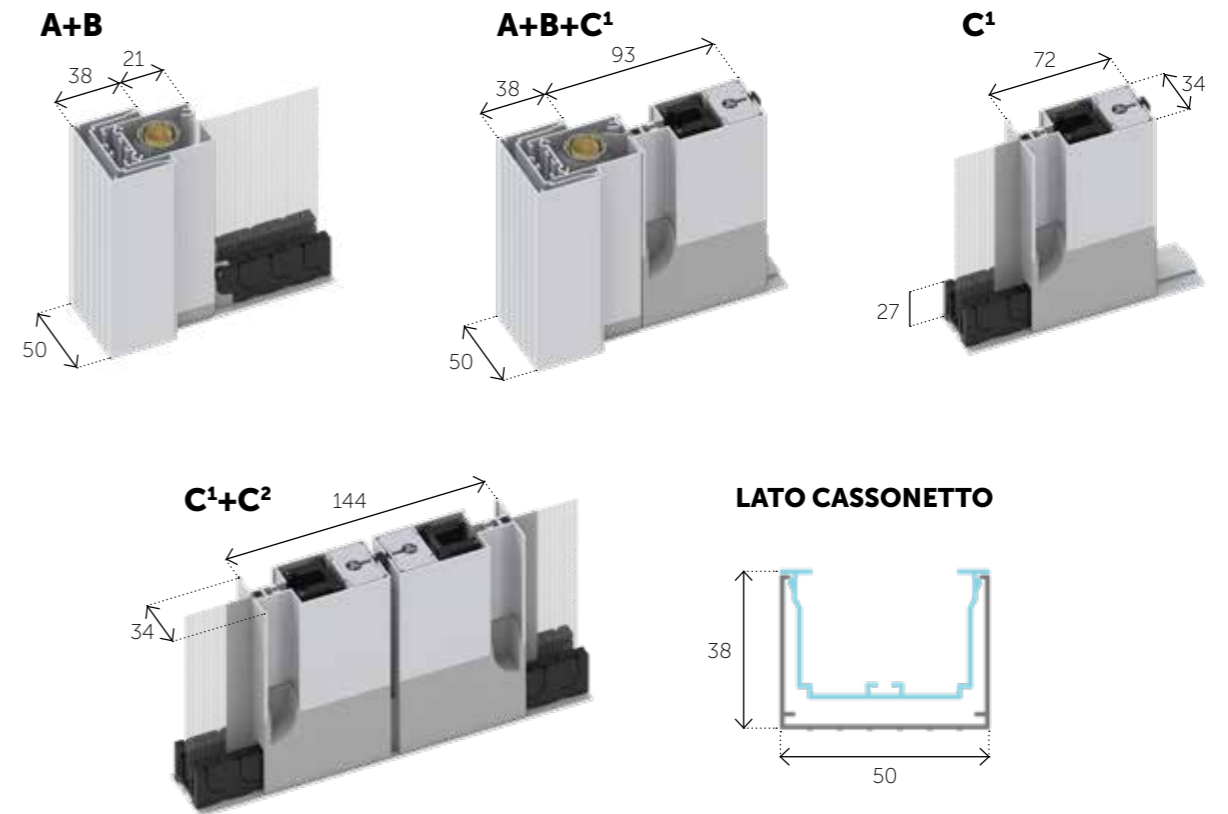
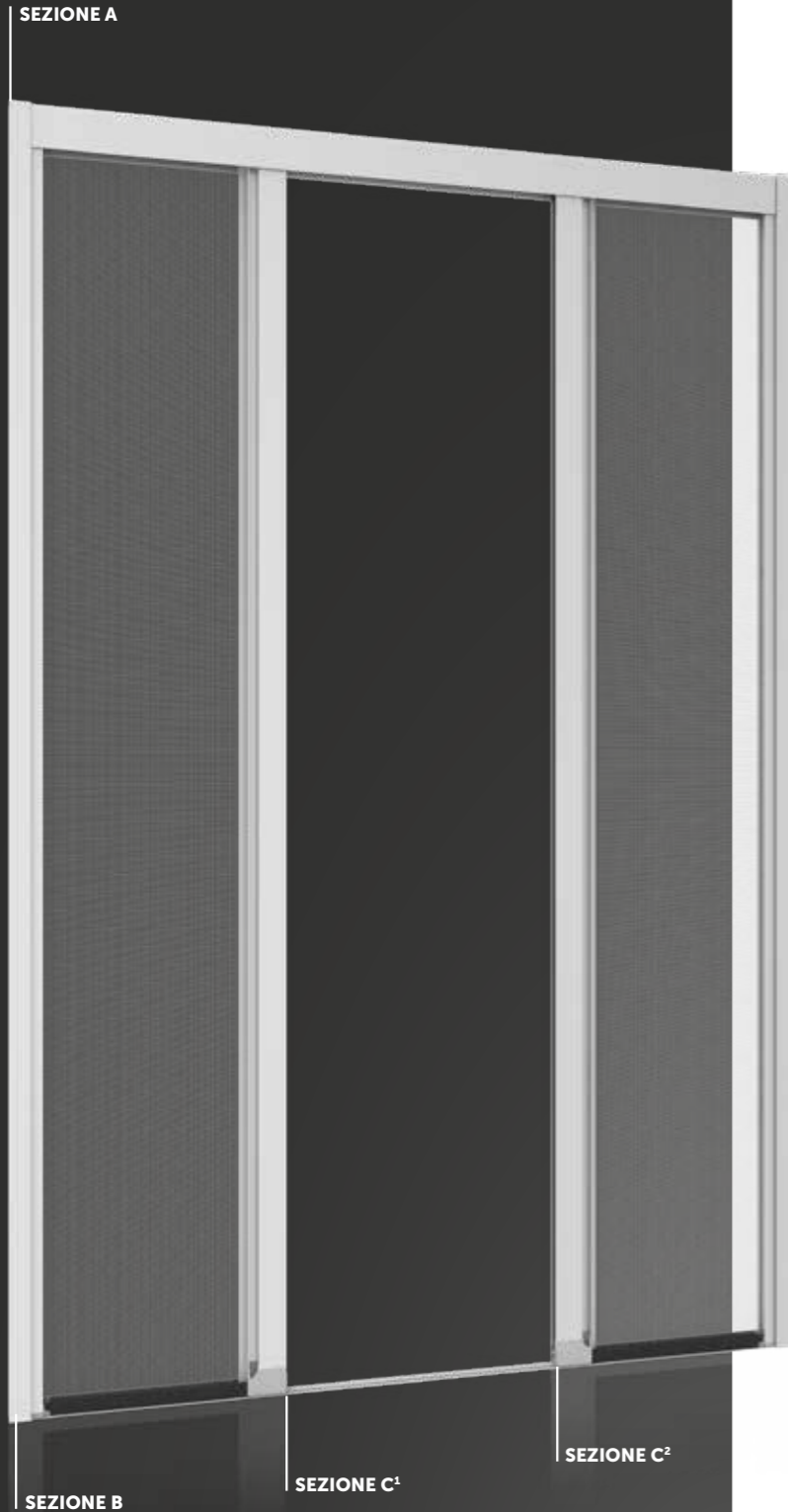

**INQUADRA IL QR CODE
CON IL TUO SMARTPHONE
E VISUALIZZA LE ISTRUZIONI
DI MONTAGGIO!**



**MONTAGGIO
INCASSO 2 ANTE**

OPTIONAL ACCESSORI

CSI Chiusura sicura*
(su un'anta)

2CS Doppia chiusura sicura
(su entrambe le ante)

*In caso di apertura asimmetrica occorre comunicare la posizione della chiusura sicura vista interna.

TELI

	COD.	DESCRIZIONE	DIMENSIONI MASSIME
	0	Fibra grigio	3200 x 2700
	RNE	Fibra nero	3200 x 2700
	BN	Fibra bianco/nero	3200 x 2700
	POL	Antipolline	2800 x 2700
	TUG	Pet screen light grigio	2000 x 2700
	TUN	Pet screen light nero	2000 x 2700

INCASSO78 | 1 ANTA

SENZA DISTANZIATORE SUPERIORE

STANDARD

CHIUSURA MAGNETICA

SPAZIO INSTALLAZIONE 78MM

SWITCH 3

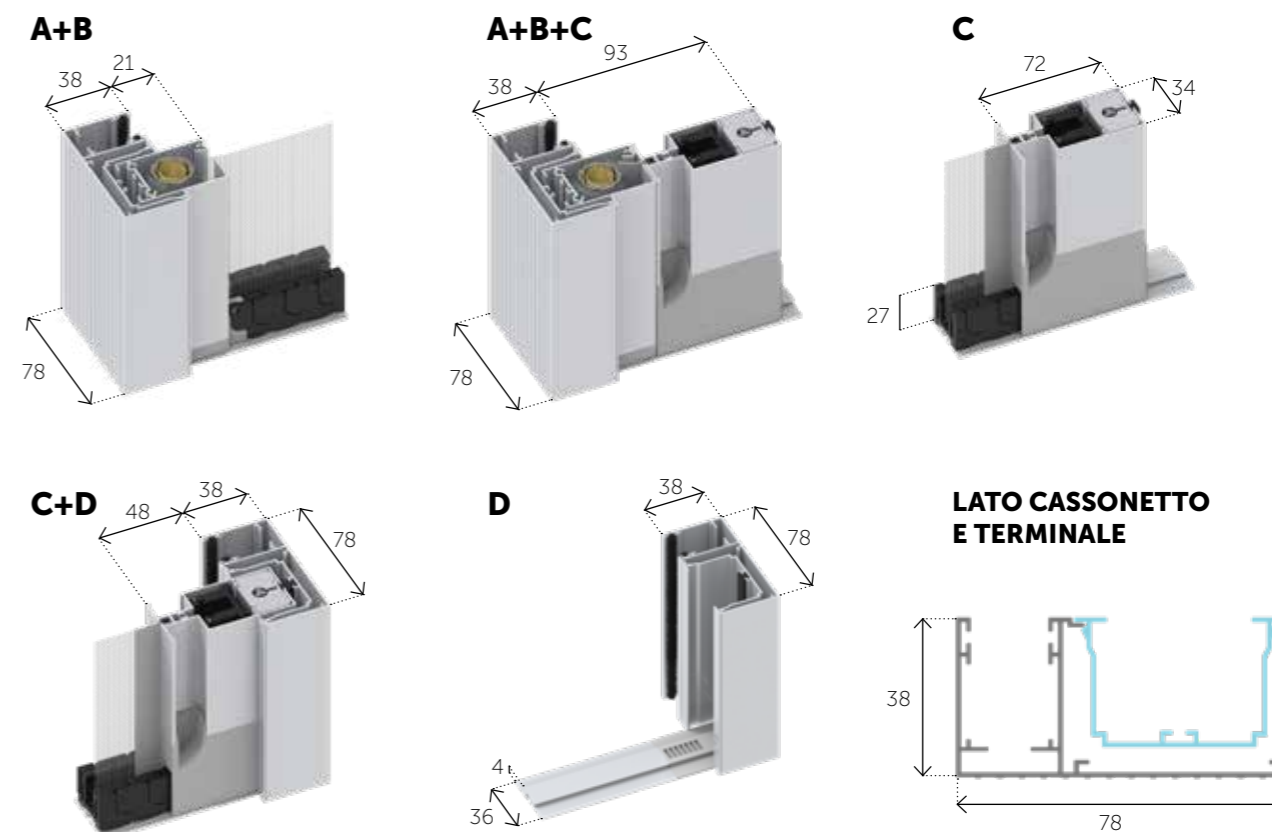
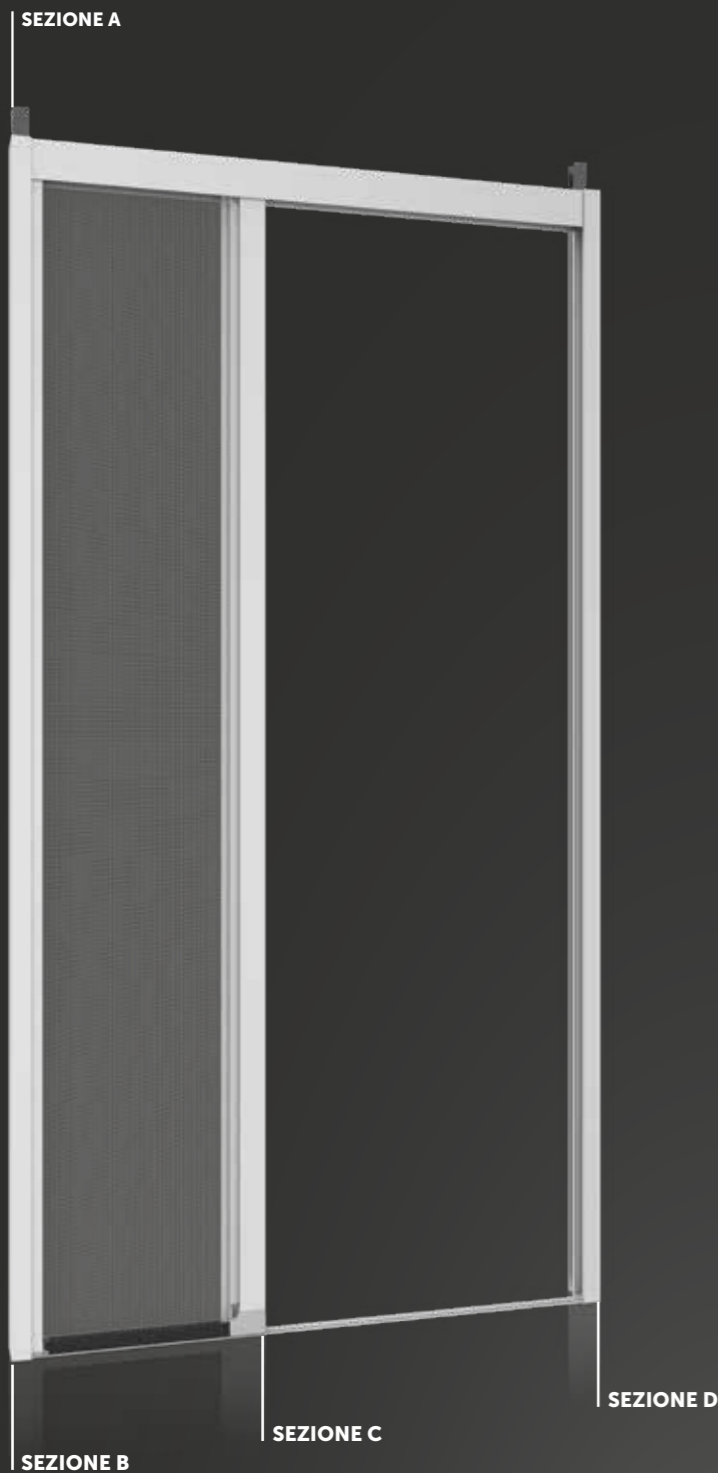







INQUADRA IL QR CODE
CON IL TUO SMARTPHONE
E VISUALIZZA LE ISTRUZIONI
DI MONTAGGIO!

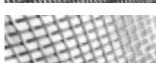

MONTAGGIO
INCASSO 1 ANTA

TELI

	COD.	DESCRIZIONE	DIMENSIONI MASSIME
	0	Fibra grigio	1600 x 2700
	RNE	Fibra nero	1600 x 2700
	BN	Fibra bianco/nero	1600 x 2700
	POL	Antipolline	1400 x 2700
	TUG	Pet screen light grigio	1000 x 2700
	TUN	Pet screen light nero	1000 x 2700

INCASSO78 | 2 ANTE

SENZA DISTANZIATORE SUPERIORE

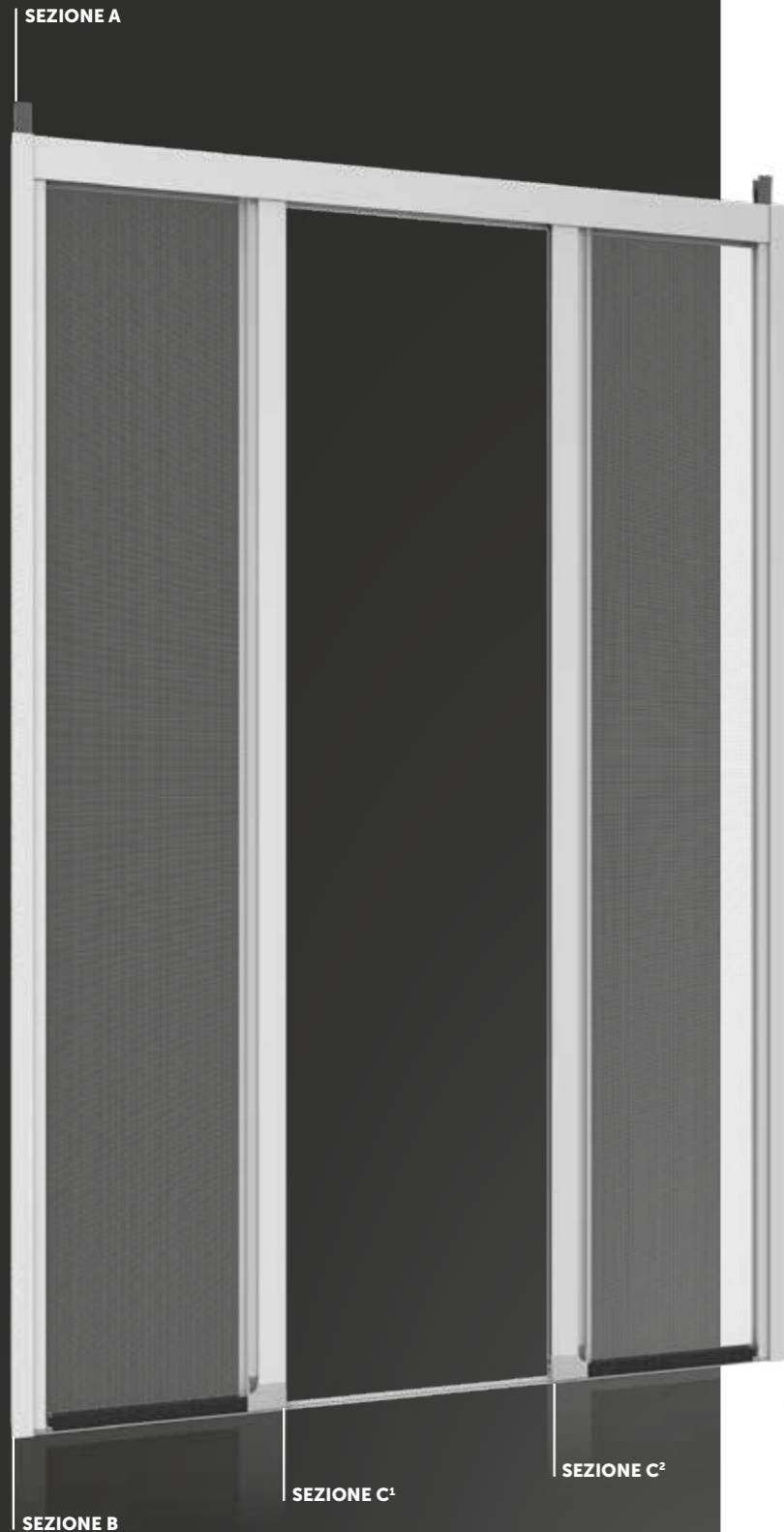

STANDARD

 CHIUSURA MAGNETICA

SPAZIO INSTALLAZIONE **78MM**

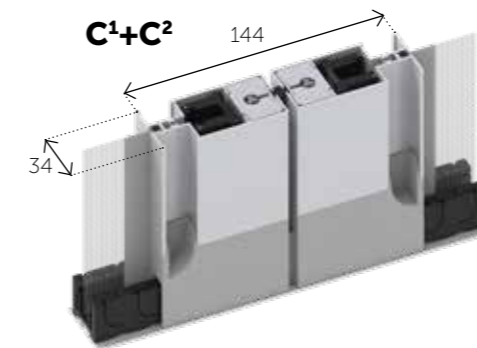
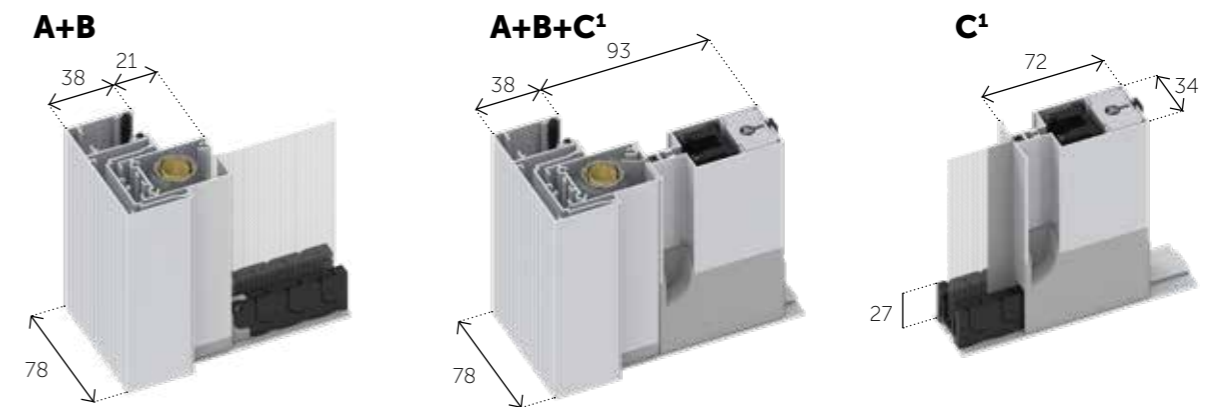

LATO CASSONETTO

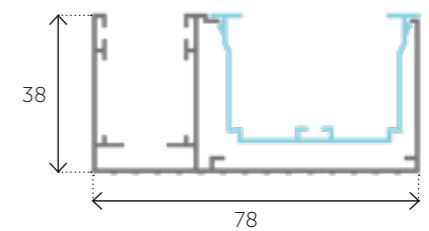

**INQUADRA IL QR CODE
CON IL TUO SMARTPHONE
E VISUALIZZA LE ISTRUZIONI
DI MONTAGGIO!**









**MONTAGGIO
INCASSO 2 ANTE**

OPTIONAL ACCESSORI

- CSI** Chiusura sicura* (su un'anta)
- 2CS** Doppia chiusura sicura (su entrambe le ante)

*In caso di apertura asimmetrica occorre comunicare la posizione della chiusura sicura vista interna.

TELI

	COD.	DESCRIZIONE	DIMENSIONI MASSIME
	0	Fibra grigio	3200 x 2700
	RNE	Fibra nero	3200 x 2700
	BN	Fibra bianco/nero	3200 x 2700
	POL	Antipolline	2800 x 2700
	TUG	Pet screen light grigio	2000 x 2700
	TUN	Pet screen light nero	2000 x 2700

STANDARD

CHIUSURA MAGNETICA

SPAZIO INSTALLAZIONE **75MM**

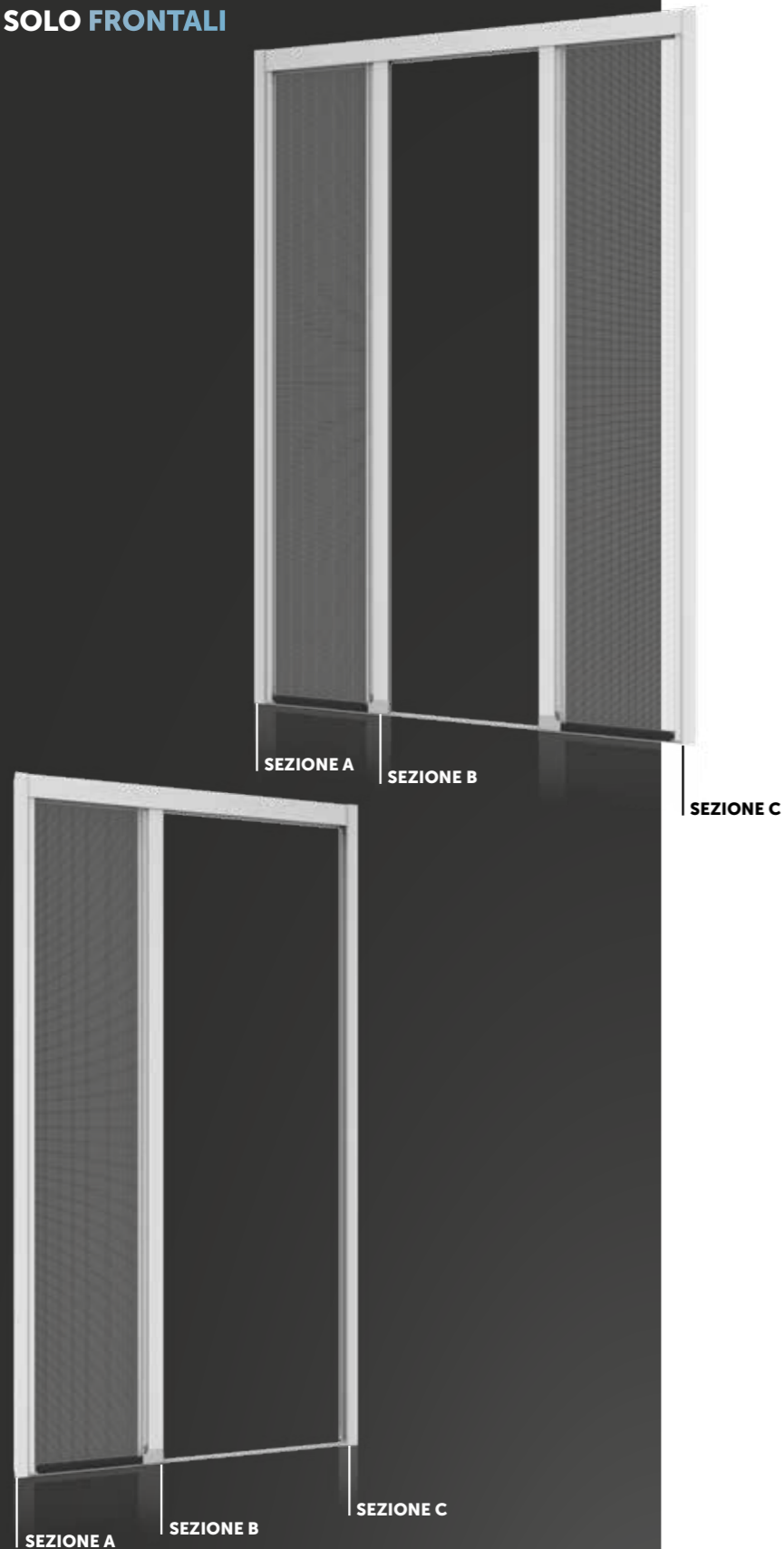

**INQUADRA IL QR CODE
CON IL TUO SMARTPHONE
E VISUALIZZA LE ISTRUZIONI
DI MONTAGGIO!**



**MONTAGGIO
MAGIC**

OPTIONAL ACCESSORI

CSI

Chiusura sicura*
(solo per due ante)

2CS

Doppia chiusura sicura
(su entrambe le ante)

*In caso di apertura asimmetrica occorre comunicare la posizione della chiusura sicura vista interna.

Fornitura della zanzariera e solo frontale in alluminio. Da applicare su distanziatore da 75 mm di altri produttori già in vostro possesso (previa verifica della compatibilità del frontale).

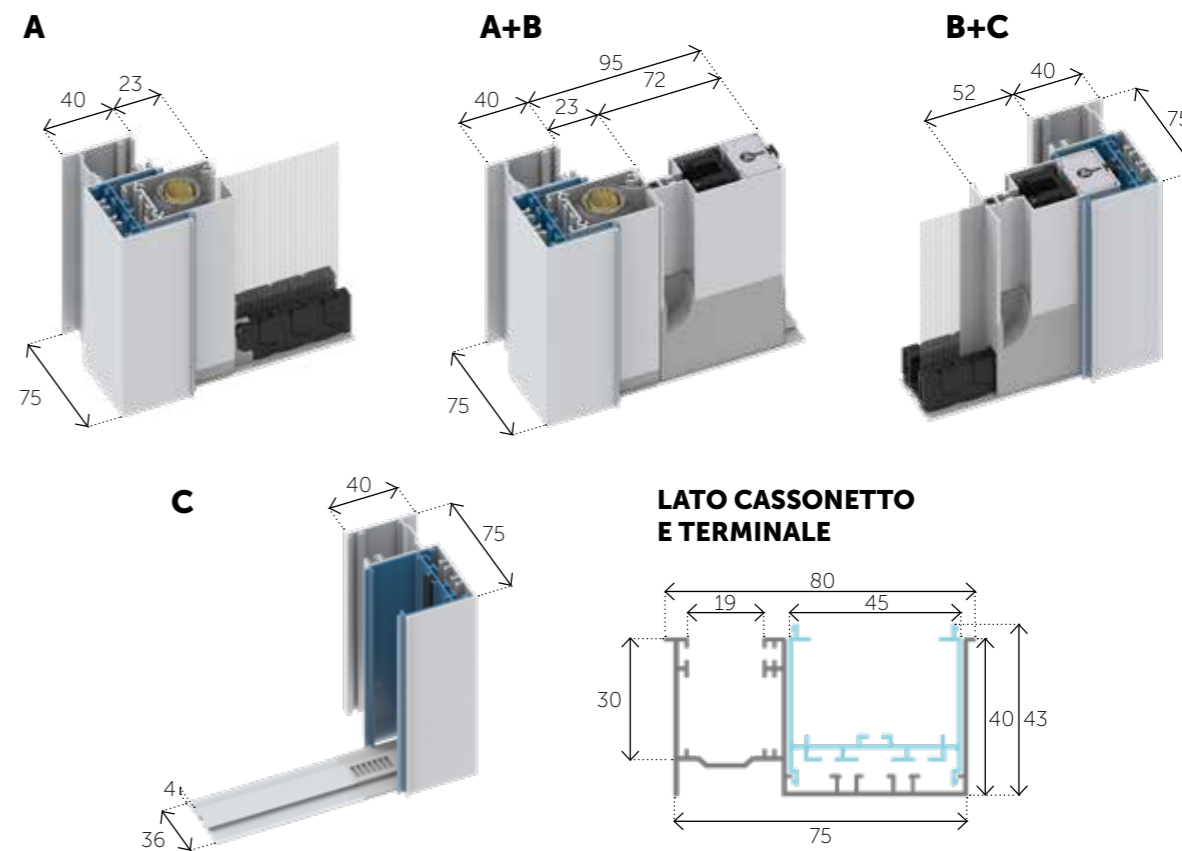

TELI

	COD.	DESCRIZIONE	DIMENSIONI MASSIME (1 ANTA)	DIMENSIONI MASSIME (2 ANTE)
	0	Fibra grigio	1600 x 2700	3200 x 2700
	RNE	Fibra nero	1600 x 2700	3200 x 2700
	BN	Fibra bianco/nero	1600 x 2700	3200 x 2700
	POL	Antipolline	1400 x 2700	2800 x 2700
	TUG	Pet screen light grigio	1000 x 2700	2000 x 2700
	TUN	Pet screen light nero	1000 x 2700	2000 x 2700

+ COMPENSATORI 1 ANTA

C COMPENSATORE SINGOLO

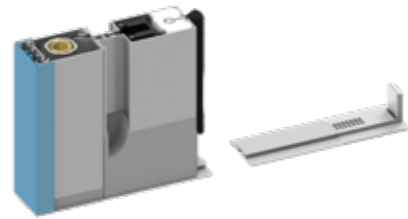

COMPENSATORE CASSONETTO

CM COMPENSATORE SINGOLO MAGNETICO

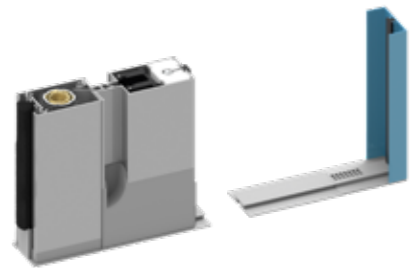

COMPENSATORE TERMINALE MAGNETICO

CCM COMPENSATORE DOPPIO MAGNETICO

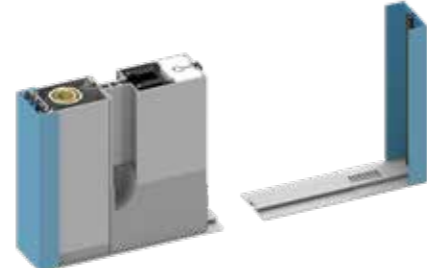

COMPENSATORE CASSONETTO E TERMINALE MAGNETICO

+ COMPENSATORI 2 ANTE

CDC CON DOPPIO COMPENSATORE



COMPENSATORE CASSONETTO E TERMINALE

+ ATTACCO SENZA VITI

ASV

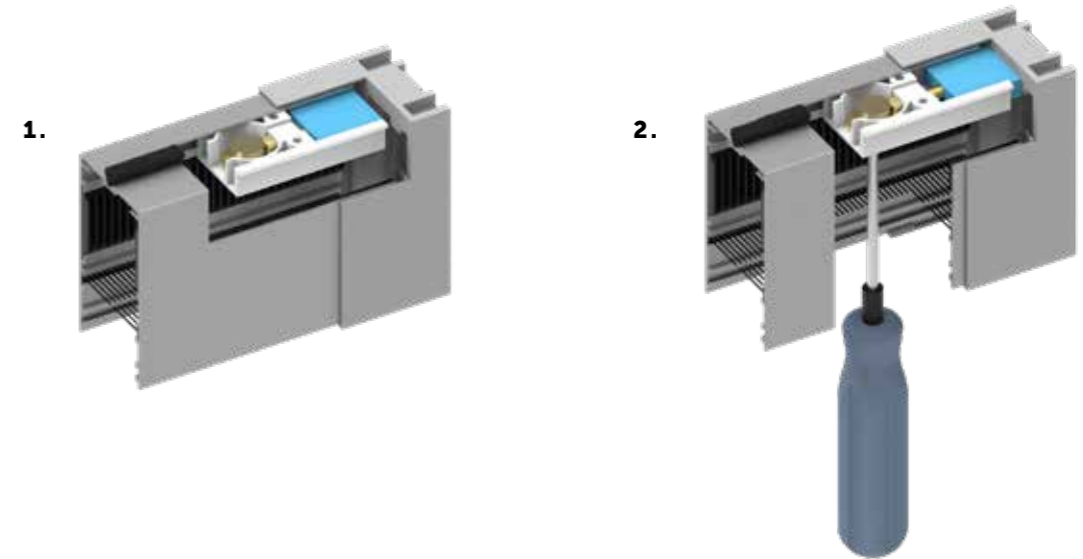

+ CHIUSURA SICURA

CSI

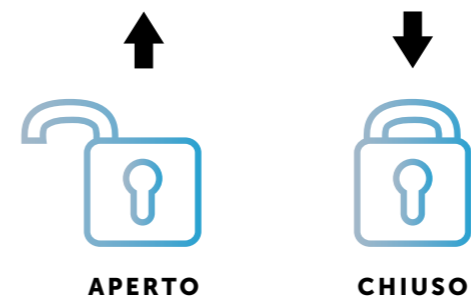

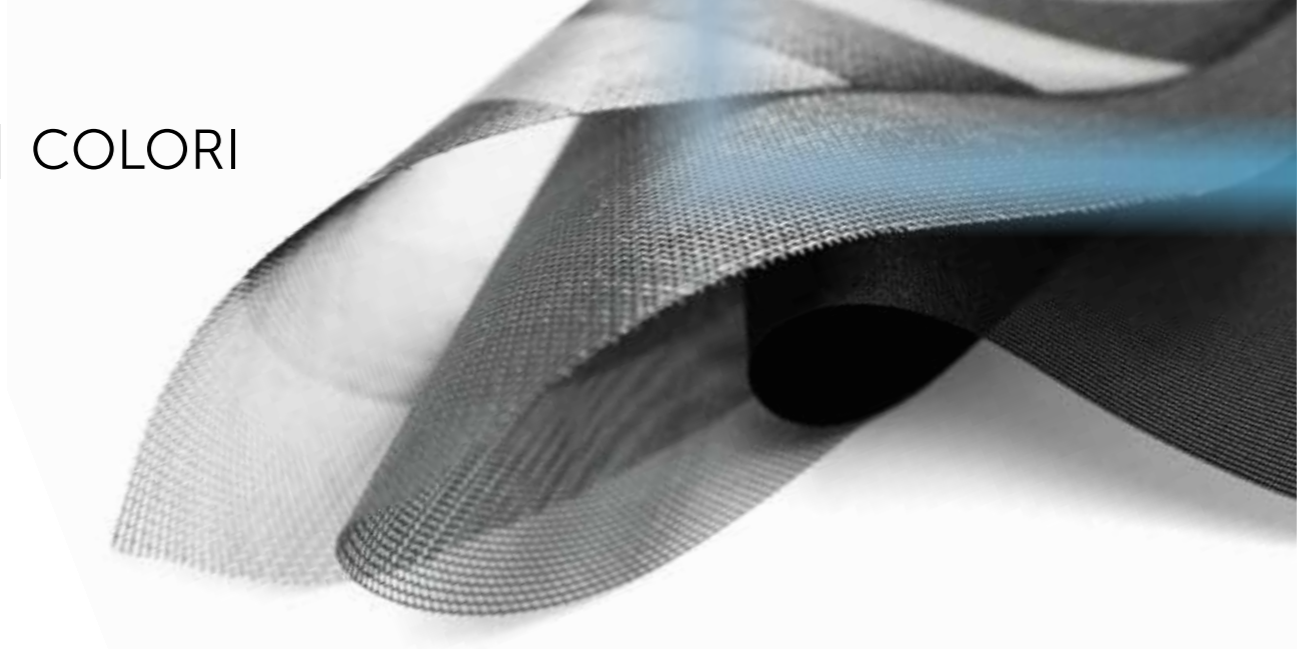

TELO
FIBRA

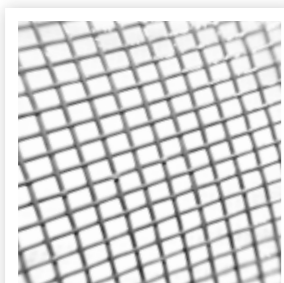

Grigio

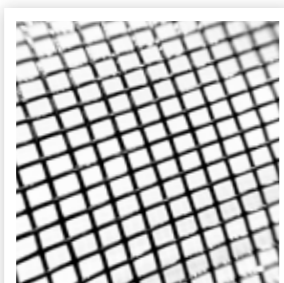

Nero

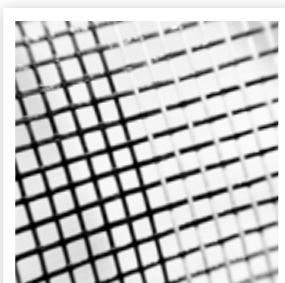

Bianco/Nero

TELO
ANTIPOLLINE



Nero

TELO
PET SCREEN LIGHT

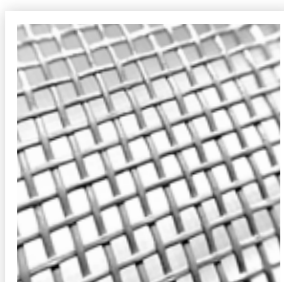

Grigio

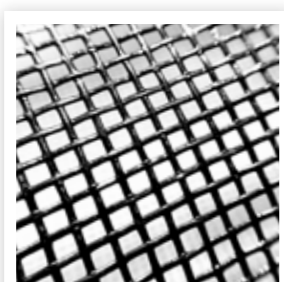

Nero

DI SERIE

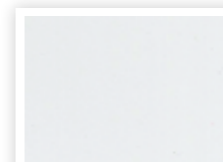

901
9010 Bianco

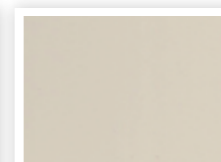

101
1013 Avorio

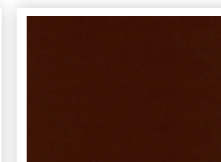

801
8017 Marrone

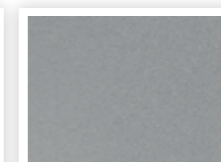

APR
Argento Verniciato Primed



BVE
Bronzo Verniciato

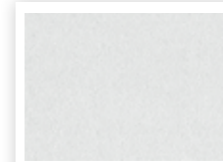

9FG
9010 Bianco Grinz

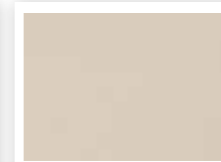

F1G
1013 Avorio Grinz

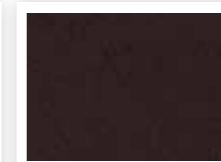

MMU
Marrone Muschio

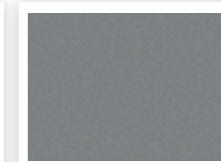

71G
7001 Grigio Grinz

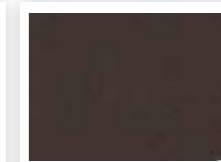

F35
Bronzo Scuro

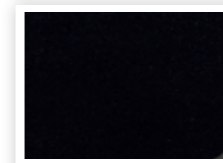

NOP
9005 Nero Opaco

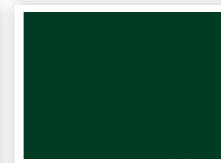

60P
6005 Verde Opaco

SPECIALI

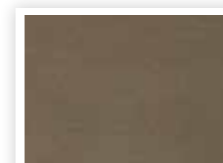

OBX
Bronzo Anodizzato

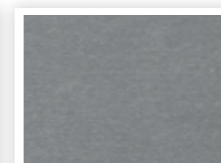

OAX
Argento Anodizzato

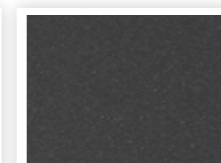

GFS
Grigio Ferro Scuro

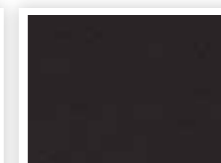

TMD
Testa di Moro Scuro

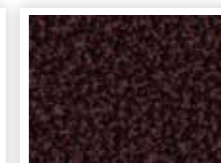

RBU
Rame Bugnato

MARMO

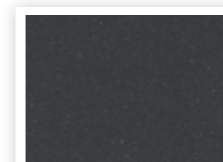

GRA
Grigio Marmo



VRA
Verde Marmo

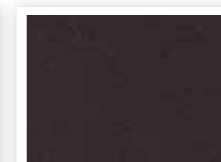

MRA
Marrone Marmo

LEGNO

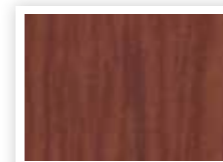

PCN
Ciliegio Natural Opaco



C21
Ciliegio Fiammato Atlantico

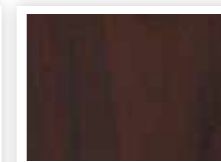

PNS
Noce Scuro Natural Opaco



DR1
Renolit Chiaro



C24
Pino Nodoso Chiaro

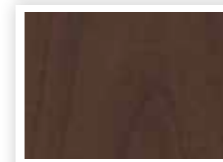

D3R
Ciliegio Fiammato Ruvido

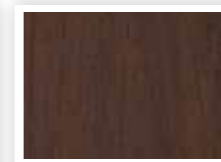

N10
Noce Ruvido

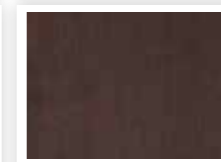

M37
Noce Scuro Ruvido

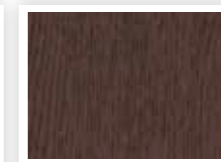

DRS
Renolit Scuro



DBE
Bianco Legno

SWITCH3

	TELI	COLORI**		
		DI SERIE	MARMO / SPECIALI	LEGNO
0	TELO IN FIBRA GRIGIO (DI SERIE)	€ 143,00 /mq	€ 157,30 /mq	€ 185,90 /mq
BN	TELO IN FIBRA BIANCO/NERO	€ 151,80 /mq	€ 166,10 /mq	€ 194,70 /mq
RNE	TELO IN FIBRA NERO	€ 151,80 /mq	€ 166,10 /mq	€ 194,70 /mq
POL	TELO ANTIPOLLINE	€ 171,60 /mq	€ 185,90 /mq	€ 214,50 /mq
TUG	PET SCREEN LIGHT GRIGIO	€ 171,60 /mq	€ 185,90 /mq	€ 214,50 /mq
TUN	PET SCREEN LIGHT NERO	€ 171,60 /mq	€ 185,90 /mq	€ 214,50 /mq

** PER TUTTI I COLORI FUORI CARTELLA, RICHIEDERE REVENTIVO AL NOSTRO UFFICIO COMMERCIALE.

OPTIONAL ACCESSORI

C	Compensatore singolo	+ 5,00% /mq
CDC	Con doppio compensatore	+ 10,00% /mq
CM	Compensatore singolo magnetico	+ 10,00% /mq
CCM	Compensatore doppio magnetico	+ 15,00% /mq
ASV	Attacco senza viti	+ € 27,50 /pz
CSI	Chiusura sicura	+ € 40,00 /pz
2CS	Doppia chiusura sicura	+ € 80,00 /pz
TOP	Attacco senza viti + Chiusura sicura	+ 15,00% /mq

NOTE

Per la versione a 2 ante, in caso di apertura asimmetrica, occorre comunicare la posizione della Chiusura Sicura vista interna.

MINIMO DI FATTURAZIONE

1 ANTA	2,0 mq
2 ANTE	4,0 mq

ISWITCH / INCASSO SWITCH3

	INCASSO	COLORI**		
		DI SERIE	MARMO / SPECIALI	LEGNO
50	INCASSO DA 50	€ 187,00 /mq	€ 205,70 /mq	€ 243,10 /mq
78	INCASSO DA 78	€ 198,00 /mq	€ 217,80 /mq	€ 257,40 /mq
IMA	INCASSO MAGIC	€ 165,00 /mq	€ 181,50 /mq	€ 214,50 /mq

** PER TUTTI I COLORI FUORI CARTELLA, RICHIEDERE REVENTIVO AL NOSTRO UFFICIO COMMERCIALE.

MAGGIORAZIONI TELI

0	Telo in fibra Grigio (DI SERIE)	-
RNE	Telo in fibra Nero	+ € 8,80 /mq
BN	Telo in fibra Bianco/Nero	+ € 8,80 /mq
TUG	Pet Screen Light Grigio	+ € 28,60 /mq
TUN	Pet Screen Light Nero	+ € 28,60 /mq
POL	Telo Antipolline	+ € 28,60 /mq

OPTIONAL ACCESSORI

CSI	Chiusura sicura	+ € 40,00 /pz
2CS	Doppia chiusura sicura	+ € 80,00 /pz
SDF	Senza distanziatori e frontali (solo modello INCASSO SWITCH 50)	- € 44,00 /mq
FR	Senza distanziatori (modello INCASSO SWITCH 50 + frontali)	- € 17,60 /mq
SDF	Senza distanziatori e frontali (solo modello INCASSO SWITCH 78)	- € 55,00 /mq
FR	Senza distanziatori (modello INCASSO SWITCH 78 + frontali)	- € 28,60 /mq

NOTE

Per la versione a 2 ante, in caso di apertura asimmetrica, occorre comunicare la posizione della Chiusura Sicura vista interna.

MINIMO DI FATTURAZIONE

1 ANTA	2,0 mq
2 ANTE	4,0 mq

COMMERCIALE@PRIMED.IT

SWITCH 3[®]

WWW.PRIMED.IT

PRIMED

LE ZANZIERE DEL FUTURO

PRIMED SRL

CORSO EUROPA, 9 | Z. I.
74023 GROTTAGLIE (TA), ITALY

T. +39 099 5623969 | FAX +39 099 5661333

P.IVA 02407940739

WWW.PRIMED.IT

**OLTRE 30 ANNI DI ESPERIENZA NELLA
PRODUZIONE E VENDITA DI ZANZARIERE
PER PORTE E FINESTRE.**

PRIMED È SINONIMO DI QUALITÀ E
AFFIDABILITÀ, UN'AZIENDA ORIENTATA
VERSO LO SVILUPPO DI PRODOTTI MODERNI
E TECNOLOGIE INNOVATIVE SENZA PERDERE
DI VISTA IL VALORE DELLA TRADIZIONE.